

AITC TECHNICAL NOTE 7

CALCULATION OF FIRE RESISTANCE OF GLUED LAMINATED TIMBERS

September 1984 (Updated January 1996)

American Institute of Timber Construction

7012 S. Revere Parkway Suite 140 Englewood, CO 80112

Phone 303-792-9559 • Fax 303-792-0669

•Email: info@aitc-glulam.org • Website: www.aitc-glulam.org

Model building codes have traditionally permitted heavy timber buildings to have at least the same allowable floor areas and heights as one-hour protected non-combustible construction. In most instances, one-hour fire resistive construction is not necessary when glued laminated structural members of heavy timber sizes are used. Designers are encouraged to investigate whether glued laminated members are required by the building code to have fire resistance ratings. This Technical Note will assist designers in achieving one-hour fire resistance ratings for exposed glued laminated members where required.

One-hour fire ratings for exposed (not wrapped with protective materials) glued laminated timbers can be calculated by the method shown here. This procedure is recognized by the model building codes only to determine a “**ONE-HOUR**” rating, and does not allow for higher ratings.

EQUATIONS FOR DETERMINING FIRE RESISTANCE

The equations for calculating fire resistance, t , in minutes for beams and columns/compression members are based on a minimum nominal dimension of 6 in. and are as follows:

Beams

For beams which may be exposed to fire on **four sides**,

$$t = 2.54Zb \left[4 - \left(\frac{2b}{d} \right) \right] \quad (\text{Eq. 1})$$

For beams which may be exposed to fire on **three sides**,

$$t = 2.54Zb \left[4 - \left(\frac{b}{d} \right) \right] \quad (\text{Eq. 2})$$

where b = width of a beam, in.,
 d = depth of a beam, in.,
 Z = dimensionless load factor from Figure 1.

Columns & Compression Members

For columns and compression members which may be exposed to fire on **four sides**,

$$t = 2.54Zd \left[3 - \left(\frac{d}{b} \right) \right] \quad (\text{Eq. 3})$$

For columns and compression members which may be exposed to fire on **three sides**,

$$t = 2.54Zd \left[3 - \left(\frac{d}{2b} \right) \right] \quad (\text{Eq. 4})$$

where b = larger dimension of column or compression member, in.,

d = smaller dimension of a column or compression member, in.,
 Z = dimensionless load factor from Figure 1.

Symbols used in Figures 1 & 2:

$l_e = K_e l_u$ = the effective length of a column or compression member,
 l_u = unsupported length of column or compression member (between points of lateral bracing), in.,
 K_e = effective buckling length factors from Figure 2.

The fire resistance only qualifies as one-hour if the calculated fire resistance time equals or exceeds 60 minutes.

Glued laminated timber standard sizes for 6 inch nominal widths are 5 inches and 5-1/8 inches for Southern Pine, and 5-1/8 inches for Western Species. See AITC 113, *Standard for Dimension of Structural Glued Laminated Timber*, for the complete listing of standard sizes.

Graphs 1 through 6 of this Technical Note have been prepared for use when a one-hour rating is required. These graphs show the member size required for a one-hour fire rating based on the ratio of design load to member capacity, expressed as a percentage.

BEAMS

Three Sides Exposed to Fire

In most cases, beams have only three sides exposed to fire. A beam 6-3/4 in. wide and 13-1/2 in. deep or larger can support its full capacity (design load = beam capacity) for one hour when exposed to fire. Also, a 8-3/4 in. wide beam with a depth of 7-1/2 in. or larger will support 100% of its capacity for one hour when exposed to fire.

Graph 1 shows that a 5-1/8 in. x 11-3/8 in. beam designed for 50% of its capacity has a fire resistance rating of one hour. For deeper beams of 5-1/8 in. width, the graph indicates only minor increases in fire resistance. Thus, the 5-1/8 in. wide beam may be inefficient for one-hour fire resistance. The 6-3/4 in. width is the preferred size to use in most cases.

Four Sides Exposed to Fire

For applications where beams have four sides exposed to fire, use Graph 2. Nominal 8 inch wide beams are the preferred size. A 6-3/4 in. x 27 in. deep beam designed for 100% of its capacity qualifies for a one-hour fire resistance.

When a shallower beam is required, the nominal 10 inch width should be considered. An 8-3/4 in. x 13-1/2 in. or deeper beam can support 100% of capacity and provide a fire resistance of one hour.

Note that this graph is based on the beam being laterally supported so that the capacity is not reduced by lateral instability, but the top surface is exposed.

Tension Laminations for Beams

The outer tension lamination is the most critical part of a glued laminated timber beam. Yet, when it is directly exposed to a fire, it will be almost completely consumed at the end of one hour. For this reason, an extra tension lamination is required for all bending combinations to achieve one-hour fire resistance. This is accomplished by adding an extra outer tension lamination and removing one of the core laminations.

(Note: The extra tension lamination is not required for columns and arches.)

COLUMNS AND COMPRESSION MEMBERS

The performance of columns and compression members under fire conditions is influenced by the effective length to depth ratio as well as by the number of sides exposed to fire. The effective length of a column or compression member l_e is determined as follows:

$$l_e = K_e l_u$$

where K_e = factor from Figure 2 for end support conditions,

l_u = length of the column or compression member between points of lateral bracing or support.

Three Sides Exposed to Fire

The equation for columns and compression members exposed to fire on 3 sides applies when the unexposed face is the smaller dimension. Where the column or compression member is partially recessed in a wall, the full size shall be used for the purpose of calculations.

Columns or compression members with an l_e/d greater than 11. Graph 3 shows the sizes required to achieve a fire resistance rating of one hour based on the percentage of capacity when three sides are exposed to fire. The sizes shown in Graph 3 may also be used in arch design.

Columns or compression members with an l_e/d less than or equal to 11. Graph 6 shows the sizes required to achieve a fire resistance rating of one hour based on the percentage of capacity when three sides are exposed to fire. An 8-3/4 in. \times 7-3/4 in. or larger column or compression member with an l_e/d of less than or equal to 11, can support 100% of capacity and provide a fire resistance of one hour.

Four Sides Exposed to Fire

Columns or compression members with an l_e/d greater than 11. Graph 4 shows the sizes required to achieve a fire resistance rating of one hour based on the percentage of capacity when four sides are exposed to fire. Smaller sizes are also shown for use with arch design.

Columns or compression members with an l_e/d less than or equal to 11. Graph 5 shows the sizes required to achieve a fire resistance rating of one hour based on the percentage of capacity when four sides are exposed to fire for l_e/d less than or equal to 11. Note that a 10-3/4 in. \times 10-1/2 in. or larger column or compression member can support 100% of capacity when four sides are exposed to fire.

ARCHES

A conservative solution can be obtained by using the following procedure:

1. Assume the arch is a compression member.
2. Use the l_e/d of the cross section(s) being analyzed to determine the appropriate graph.
3. Use the sizes and percentages of capacity at several points along the arch leg to determine the fire rating.

CONNECTIONS AND FASTENINGS

The supports and fastenings for one-hour rated members must also be capable of resisting a fire for one hour. See the details in Figures 3 through 8 for connections and fastenings.

SPECIFICATION

The designer should specify when a glued laminated timber member is required to have a one-hour fire rating.

EXAMPLES

Beams

Determine the size of a Southern Pine glued laminated timber for the following conditions:

One-hour fire rating is required.

Simple span beam supported on columns and exposed to fire on three sides. Use Eq. 2.

Span = 40 ft. Spacing = 20 ft.

Design Dead Load = 15 psf. Live Load = 20 psf reduced to 12 psf by code reduction for tributary area.

The beam is laterally braced continuously along the top by roof framing and sheathing.

Glued laminated timber to be combination 24F-V3, Southern Pine.

Tabular design values are: $F_{bx} = 2400$ psi; $F_v = 240$ psi; $E = 1,800,000$ psi.

Load duration factor: $C_D = 1.25$ (not for snow loads).

Analyze bending stresses.

Adjusted design value for bending: $F_{bx}^* = 2400 (1.25) = 3000$ psi.

$M = wL^2/8 = 540(40)^2(12)/8 = 1,296,000$ in.-lb

Try $C_V = 0.90$.

$$\text{Section Modulus required} = S_x = \frac{M}{F_{bx}^* C_V} = \frac{1,296,000}{(3000)(0.90)} = 480 \text{ in.}^3$$

A 5-1/8 in. x 24-3/4 in. beam provides an $S_x = 523.2$ in.³

Calculate C_V using an exponent of 1/20 for Southern Pine.

$C_V = 0.934$.

$$\text{Section Modulus} = S_x = \frac{M}{F_{bx}^* C_V} = \frac{1,296,000}{(3000)(0.934)} = 462.5 \text{ in.}^3 < 523.2 \text{ in.}^3$$

Percentage of design load to capacity of beam = $462.5/523.2 = 88.4\%$

From Figure 1, based on 88.4%, $Z = 1.04$.

$t = 2.54 (1.04)(5.125)[4 - (5.125/24.75)] = 51.3$ minutes. This does not meet a one-hour rating, therefore an increase in size is required. Graph 1 shows that for 5-1/8 inch width beams, there is very little benefit for increased depths. However, increased beams widths significantly increase fire resistance. Try a 6-3/4 in. x 20-5/8 in. beam that provides $S_x = 478.6$ in.³ and $C_V = 0.930$.

$$\text{Section Modulus} = S_x = \frac{M}{F_{bx}^* C_V} = \frac{1,296,000}{(3000)(0.930)} = 464.5 \text{ in.}^3 < 478.6 \text{ in.}^3$$

The percentage of design load to capacity of beam equals $464.5/478.6$, or 97.1%.

From Figure 1, based on 97.1%, $Z = 1.01$.

$t = 2.54(1.01)(6.75)[4 - (6.75/20.625)] = 63.6$ minutes. This qualifies as one-hour fire-resistive.

(Note: When four sides are exposed to fire as shown in Graph 2, an 8-3/4 in. wide beam should be considered in addition to the 6-3/4 in. wide beam.)

The percentage of load should be applied to shear as well as bending. If the percentage of design load for shear exceeds the percentage for bending, the member should be resized to meet the shear requirement.

Design shear load = $540[40 - 2(20.625/12)]/2 = 9870$ lb

$$\text{Beam shear capacity} = V = \frac{2bdF_V}{3} = \frac{2(6.75)(20.625)(300)}{3} = 27,840 \text{ lb}$$

$$\text{Design shear load/beam shear capacity} = \frac{9870}{27840} = 35.5\% < 97.1\%; \text{ therefore bending controls.}$$

Use a 6-3/4 in. × 20-5/8 in. beam with additional tension lamination.

Columns

Determine the size of a Douglas Fir - Larch glued laminated column for the following conditions:

Length = 20 ft. Loaded concentrically, creating axial compression.

Dead Load plus Snow Load = 100,000 lb

Four sides are exposed to fire.

From Figure 2, the buckling mode in the fourth column is typically used for wood columns (rotation free, translation fixed both top and bottom).

The effective length of the column $l_e = K_e l_u = (1.00)(20) = 20 \text{ ft} (12) = 240 \text{ in.}$

Using Combination 2, Douglas Fir - Larch, $F_c = 1900 \text{ psi}$, $E = 1,700,000 \text{ psi}$.

$F_c^* = (1,900)(1.15) = 2,185 \text{ psi}$; $E' = E = 1,700,000 \text{ psi}$.

Try a 10-3/4 in. × 12 in. column, $A = 129.0 \text{ in.}^2$

$$l_e/d = \frac{240}{10.75} = 22.33 > 11$$

$$c = 0.9, K_{cE} = 0.418$$

$$F_{cE} = \frac{K_{cE} E'}{(l_e / d)^2} = 1426 \text{ psi}$$

$$F_{cE} / F_c^* = 1426/2185 = 0.653$$

$$C_P = \frac{1 + (F_{cE} / F_c^*)}{2c} - \sqrt{\left[\frac{1 + (F_{cE} / F_c^*)}{2c} \right]^2 - \frac{F_{cE} / F_c^*}{c}}$$

$$C_P = 0.575$$

$$F_c' = F_c^* C_P = 2185(0.575) = 1256 \text{ psi.}$$

$$P = AF_c' = (129)(1,256) = 162,024 \text{ lb}$$

Percentage of design load to capacity of column equals $100,000/162,024$, or 61.7%.

From Figure 1, based on 61.7%, $Z = 1.20$ (rounded to the nearest 0.01).

$$t = 2.54(1.20)(10.75)[3 - (10.75/12)] = 68.9 \text{ minutes. Therefore, O.K.}$$

From Graph 4, for $l_e/d > 11$, a 10-3/4 in. × 12 in. column can support 86% of the design load.

$$P = (162,024)(0.86) = 139,341 > 100,000 \text{ lb. Therefore, it is permissible to use the 10-3/4 in. × 12 in. column.}$$

Arches

Determine the fire resistance of a Tudor arch with four sides exposed to fire. The critical section of the arch is 6-3/4 in. wide and 20 in. deep. The arch leg is 10 ft and is not laterally braced.

For combination 24F-V3, Southern Pine glued laminated timber arch, the design values are: $F_c = 1700 \text{ psi}$;

$F_{bx} = 2400 \text{ psi}$; $F_{by} = 1600 \text{ psi}$; $E_x = 1,800,000 \text{ psi}$; $E_y = 1,600,000 \text{ psi}$.

The controlling load combination is Dead Load plus Construction Live Load ($C_D = 1.25$). The equation for combined bending (about the x-x axis) and axial compression (see page 5-273 of the AITC *Timber Construction Manual*, 4th Edition) is:

$$\frac{f_c}{F_c} + \frac{f_{bx}}{F_{bx}} \leq 1.0$$

This calculation gives a design load stress ratio equal to 0.745 (74.5%). Determine whether the arch at this section has a one-hour fire rating.

The l_e/d ratio at this cross section = $10(12)/6.75 = 17.78 > 11$, therefore Eq. 3 and Graph 4 apply.

From Graph 4, the ratio of design load to member capacity for a 6-3/4 in. x 20 in. compression member ($l_e/d > 11$) is less than 50%, which is less than 74.5%; therefore, a larger section is required. The most efficient method for this particular cross section is to increase the width to 8-3/4 in. However, if in reviewing the total arch design, as well as the proportion of widths to depths, it is decided that the width should remain at 6-3/4 in., the depth must be increased. Try the new size controlling cross section with a width of 6-3/4 in. and a depth of 24.675 in. This results in a design load stress ratio equal to 0.514 (51.4%).

From Graph 4, the ratio of design load to capacity for a 6-3/4 in. x 24-3/4 in. compression member is 51.5%, which is greater than 51.4%. Therefore, this section achieves a one-hour rating.

Other sections of the arch should be checked by the same procedure.

To illustrate the use of Figure 1 and Eq. 4, check the fire resistance rating for the same arch cross section exposed to fire on three sides. Based on ratio of 51.4%, $Z = 1.29$ (from Figure 1).

$$t = 2.54(1.29)(6.75) \left[3 - \frac{6.75}{2(24.75)} \right] = 63.3 \text{ minutes} > 60 \text{ minutes. Therefore, one hour rating.}$$

To illustrate the use of Graph 3, the ratio of the design load to member capacity for a 6-3/4 in. x 24-3/4 in. compression member equals 58.5%. Then from Figure 1, $Z = 1.23$.

$$t = 2.54(1.23)(6.75) \left[3 - \frac{6.75}{2(24.75)} \right] = 60.4 \text{ minutes} > 60 \text{ minutes. Therefore, one hour rating.}$$

REFERENCES

1. T.T. Lie, *A Method for Assessing the Fire Resistance of Laminated Beams and Columns*. National Research Council of Canada, Division of Building Research, DBR 718, Ottawa, Ontario, 1977
2. American Forest & Paper Association, ANSI/NFoPA NDS-1991, *National Design Specification For Wood Construction*, Washington, DC, 1991
3. American Institute of Timber Construction, *Timber Construction Manual*, 4th Edition, Englewood, CO, 1994

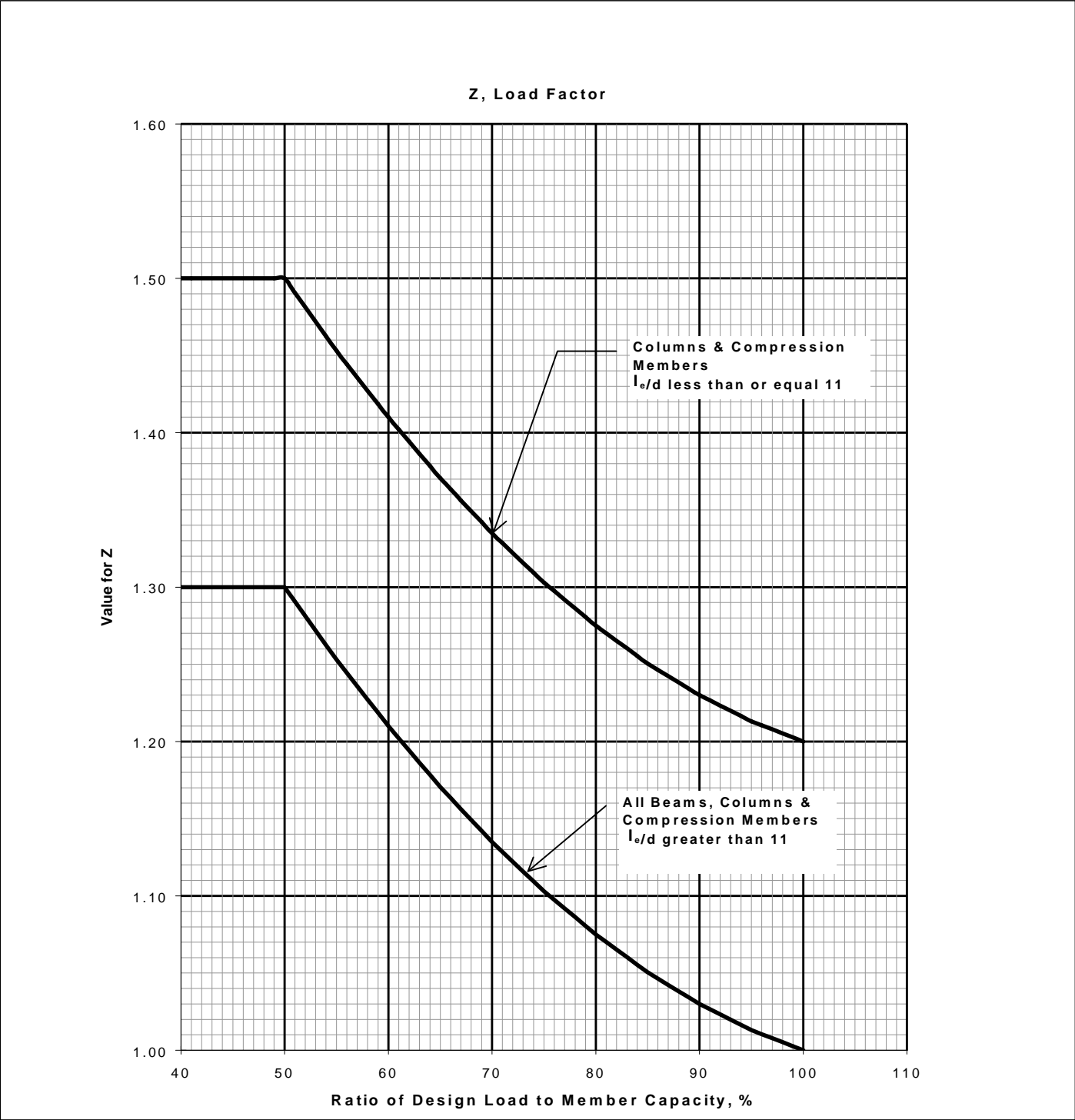
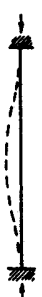
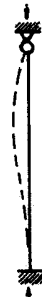
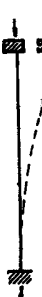

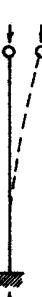







FIGURE 1

Effective Column Length for Various End Conditions¹

Buckling modes						
Theoretical K_e value	0.5	0.7	1.0	1.0	2.0	2.0
Recommended design K_e when ideal conditions approximated	0.65	0.80	1.2	1.0	2.1	2.4
End condition code	   	Rotation fixed, translation fixed Rotation free, translation fixed Rotation fixed, translation free Rotation free, translation free				

¹courtesy of American Forest & Paper Association

FIGURE 2

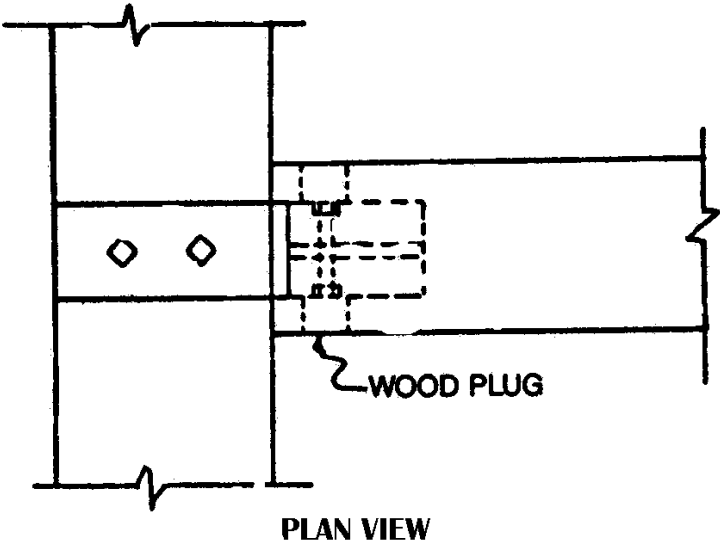

PLAN VIEW

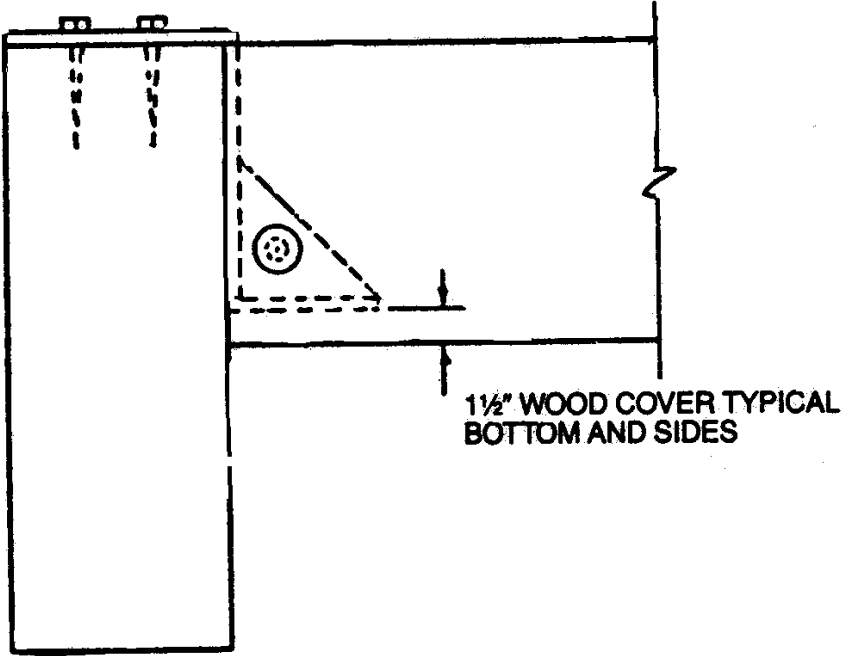

ELEVATION

BEAM TO GIRDER – CONCEALED CONNECTION

FIGURE 3

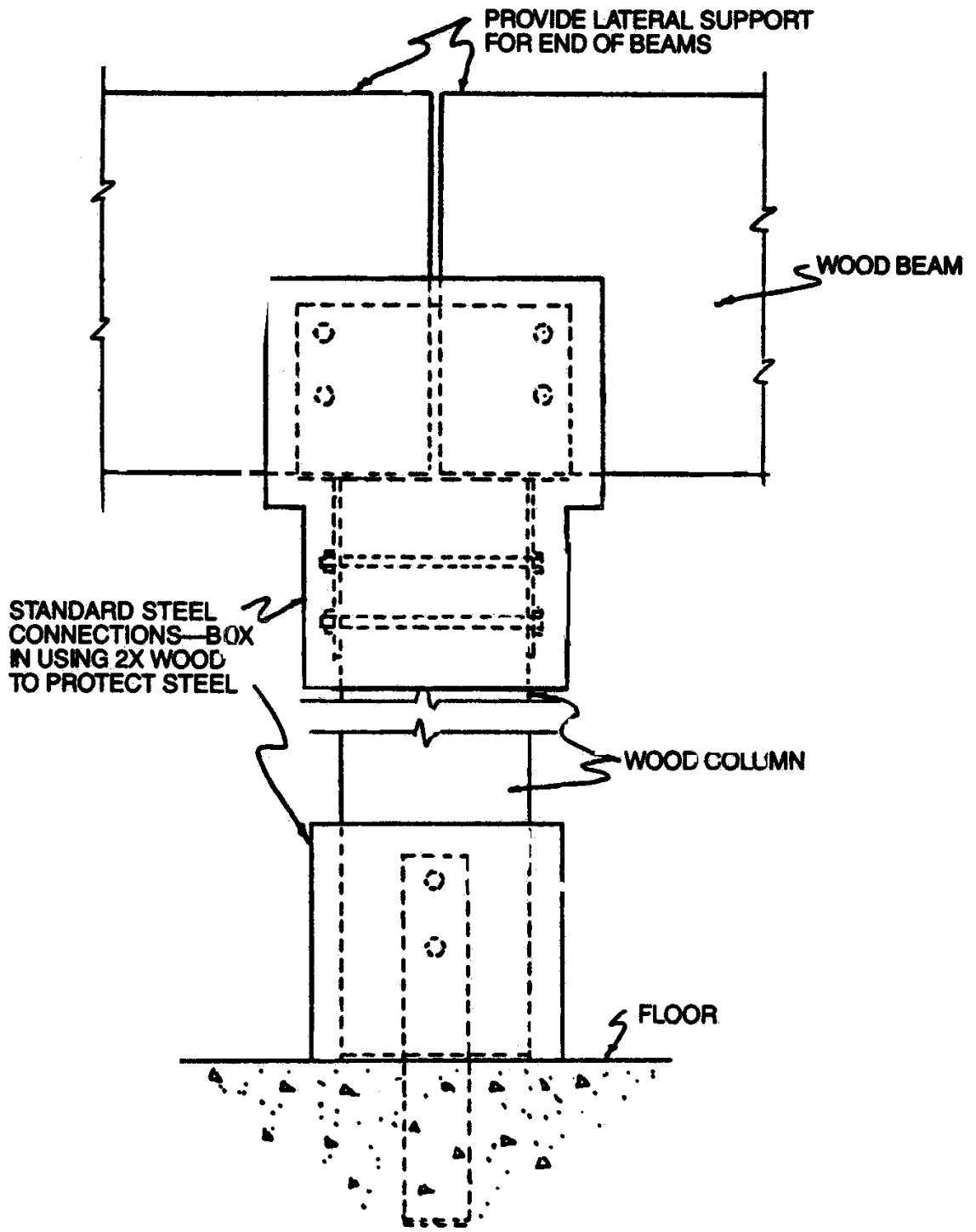

ELEVATION

COLUMN CONNECTION -- COVERED
FIGURE 4

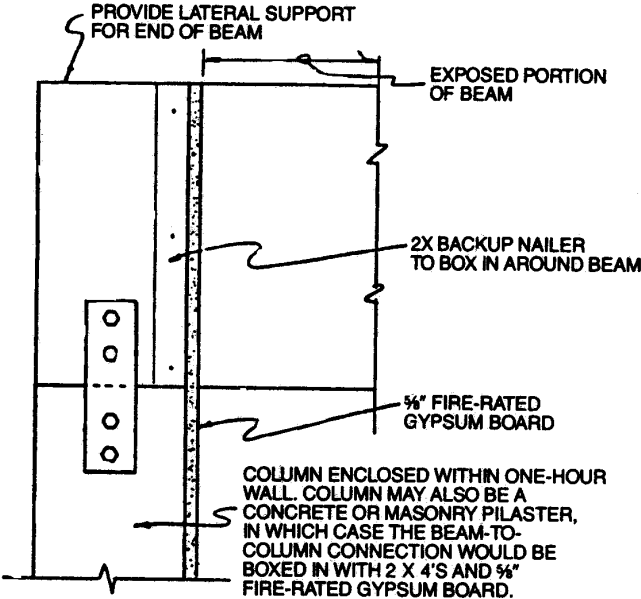

ELEVATION

BEAM-TO-COLUMN CONNECTION
CONNECTION NOT EXPOSED TO FIRE

FIGURE 5

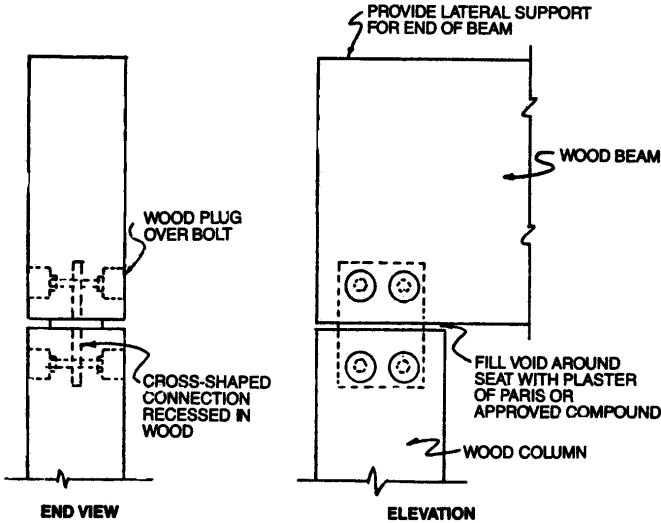

BEAM-TO-COLUMN CONNECTION
CONNECTION EXPOSED TO FIRE
WHERE APPEARANCE IS A FACTOR

FIGURE 6

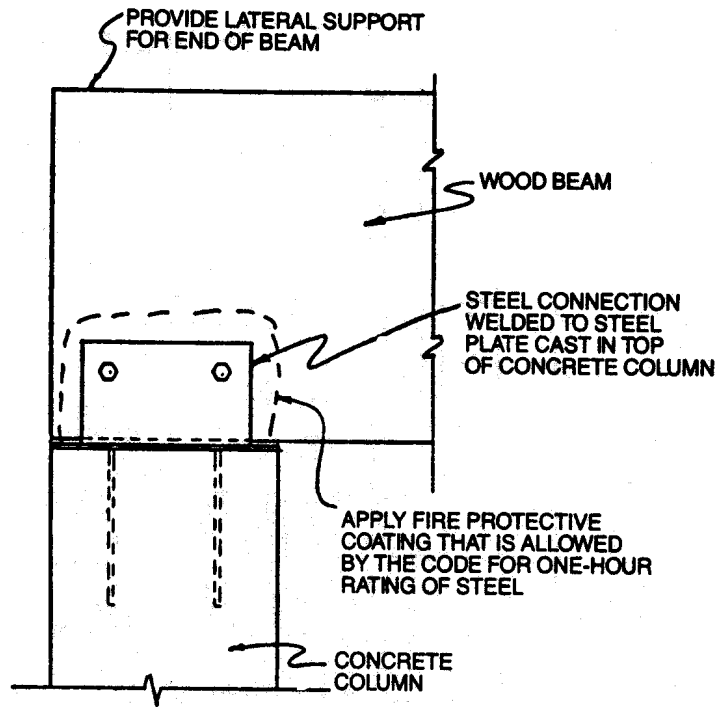

ELEVATION

BEAM-TO-COLUMN CONNECTION
CONNECTION EXPOSED TO FIRE
WHERE APPEARANCE IS NOT A FACTOR

FIGURE 7

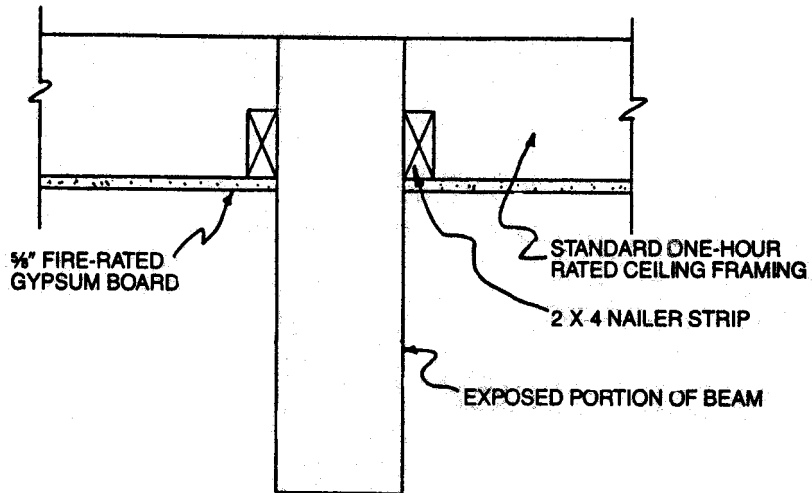

SECTION

CEILING CONSTRUCTION

FIGURE 8

**Glued Laminated Timber Beams
Three Sides Exposed to Fire
One Hour Rating**

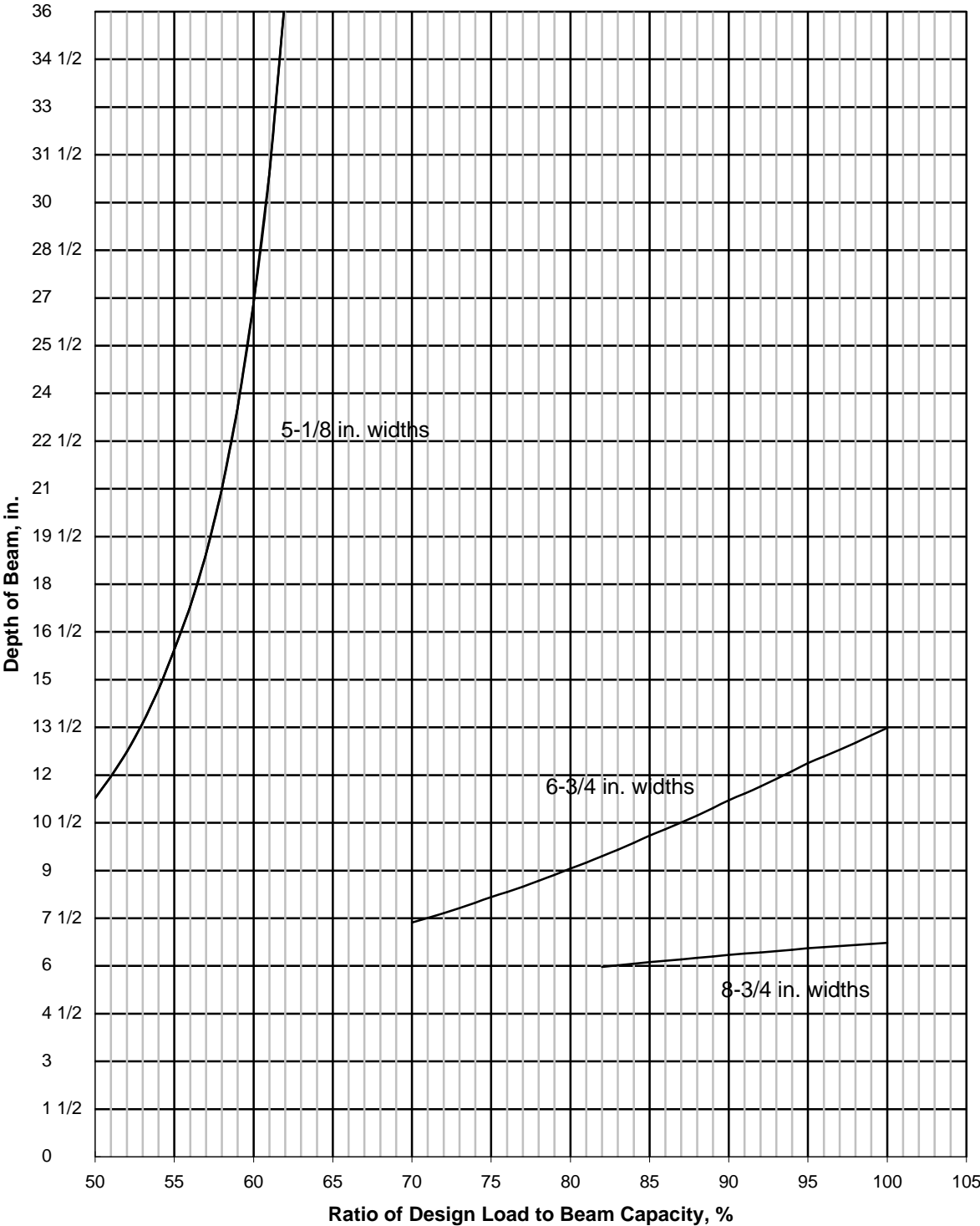

GRAPH 1

**Glued Laminated Timber Beams
Four Sides Exposed to Fire
One Hour Rating**

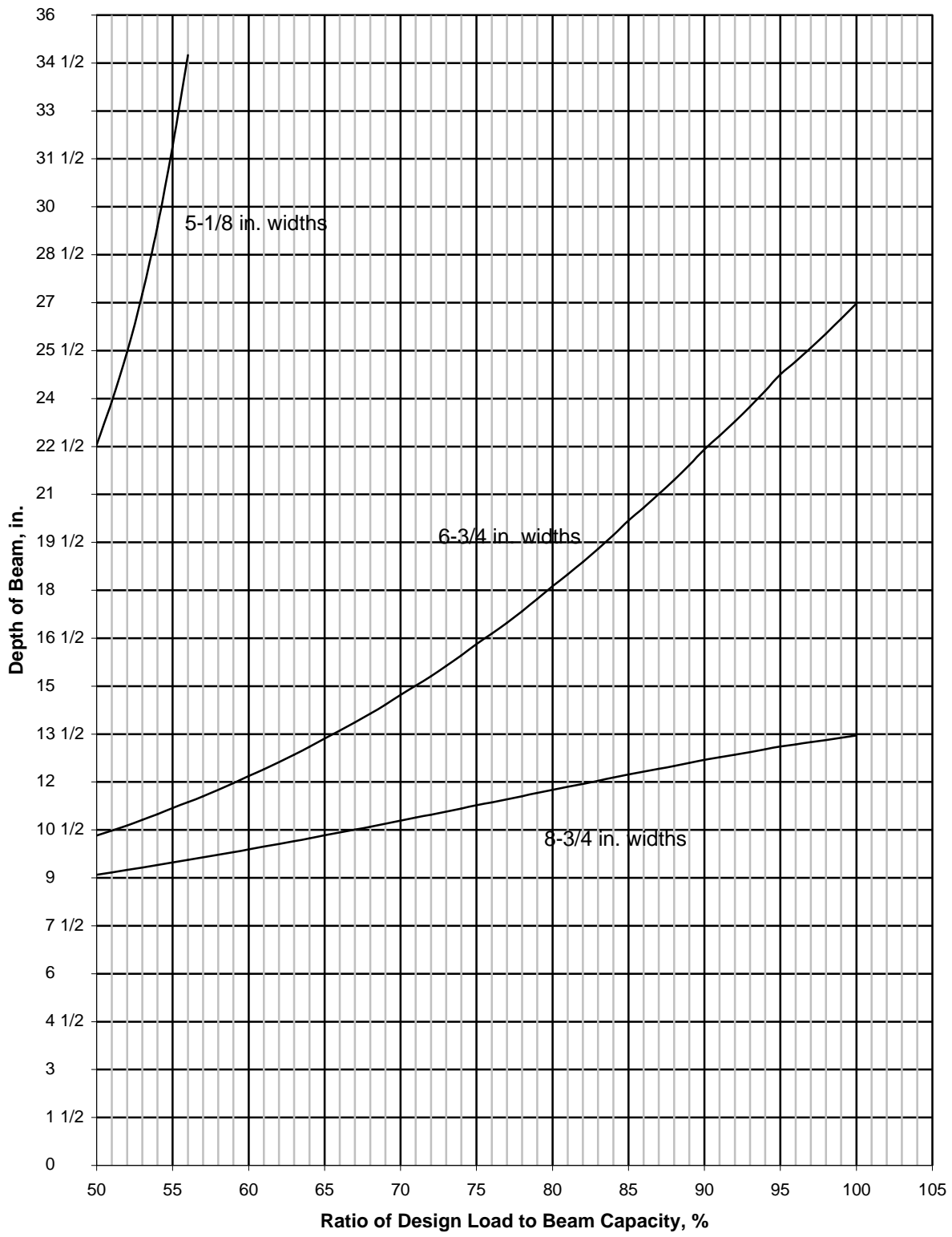

GRAPH 2

Columns & Compression Members
 $I_e/d > 11$
Three Sides Exposed to Fire
One Hour Rating

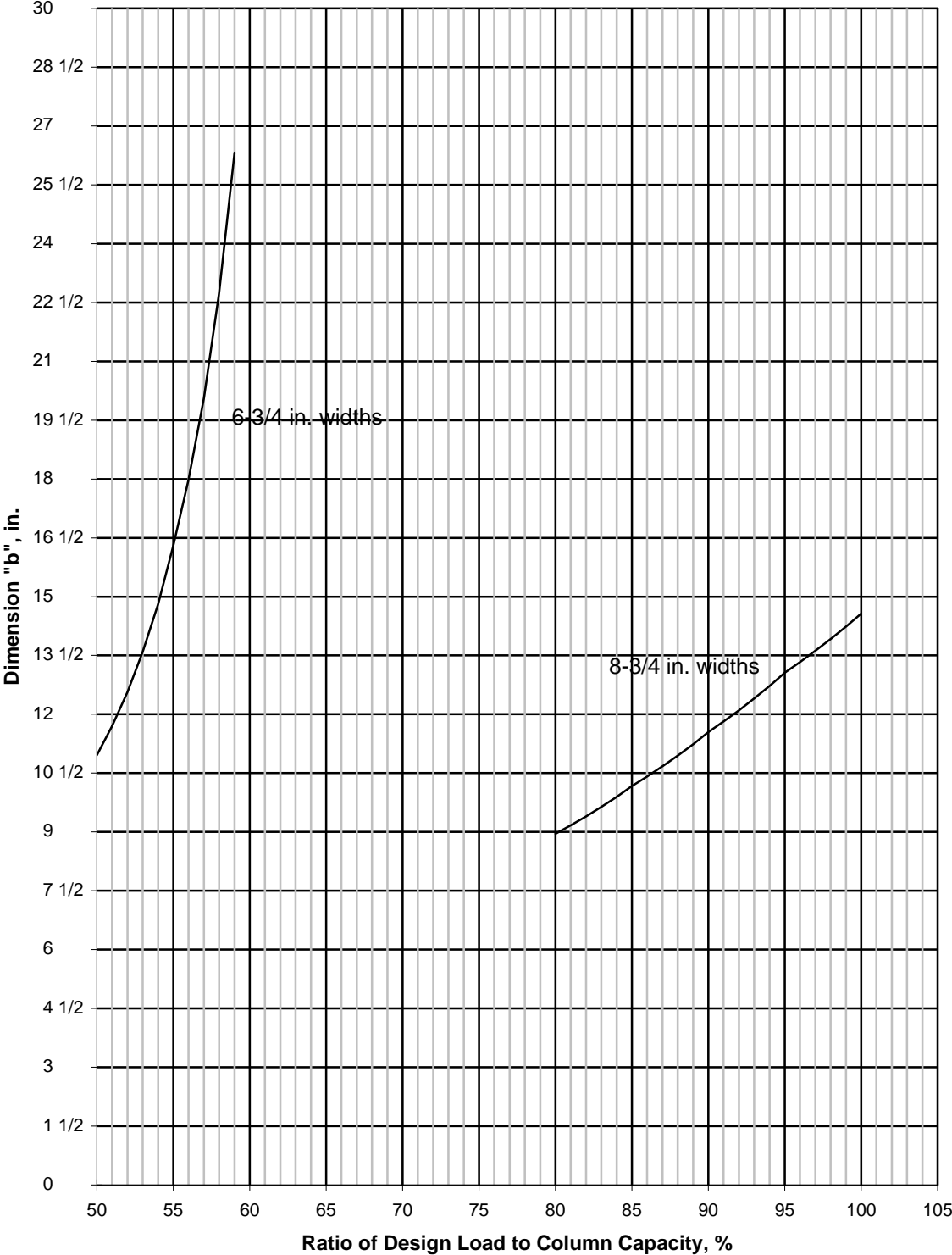

GRAPH 3

Columns & Compression Members

$I_e/d > 11$

Four Sides Exposed to Fire

One Hour Rating

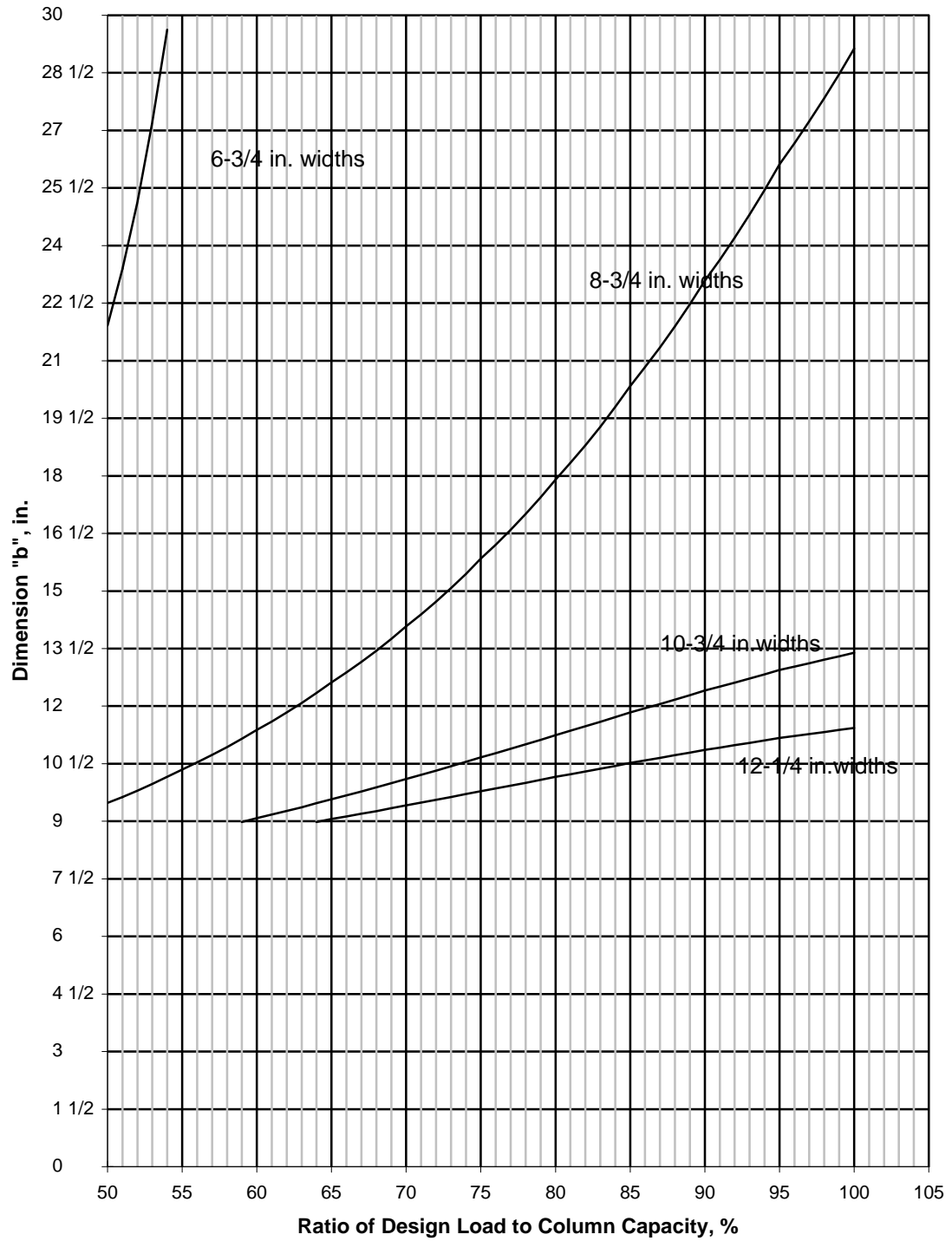

GRAPH 4

Columns & Compression Members
 l_e/d less than or = 11
Four Sides Exposed to Fire
One Hour Rating

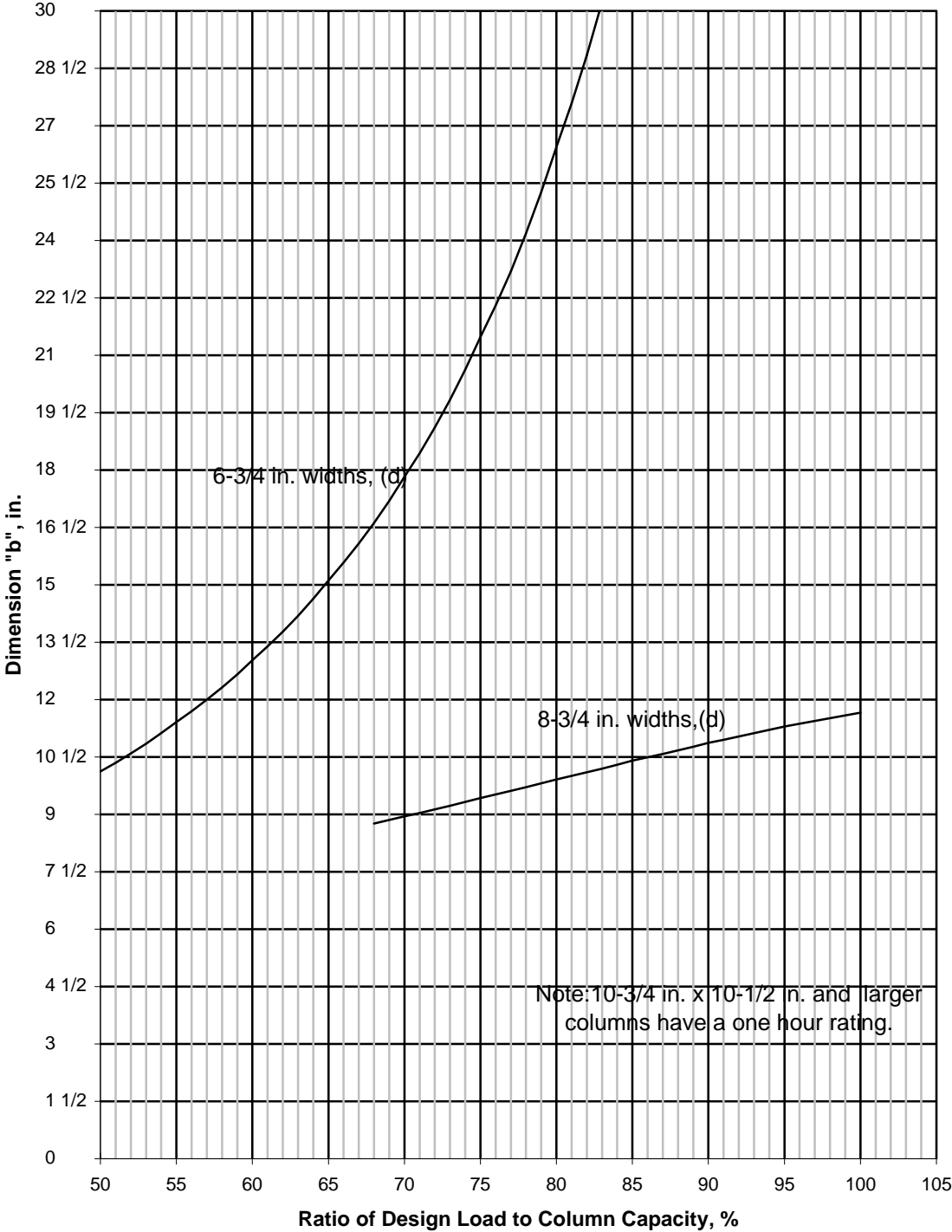

GRAPH 5

Columns & Compression Members
 I_c/d less than or = 11
 Three Sides Exposed to Fire
 One Hour Rating

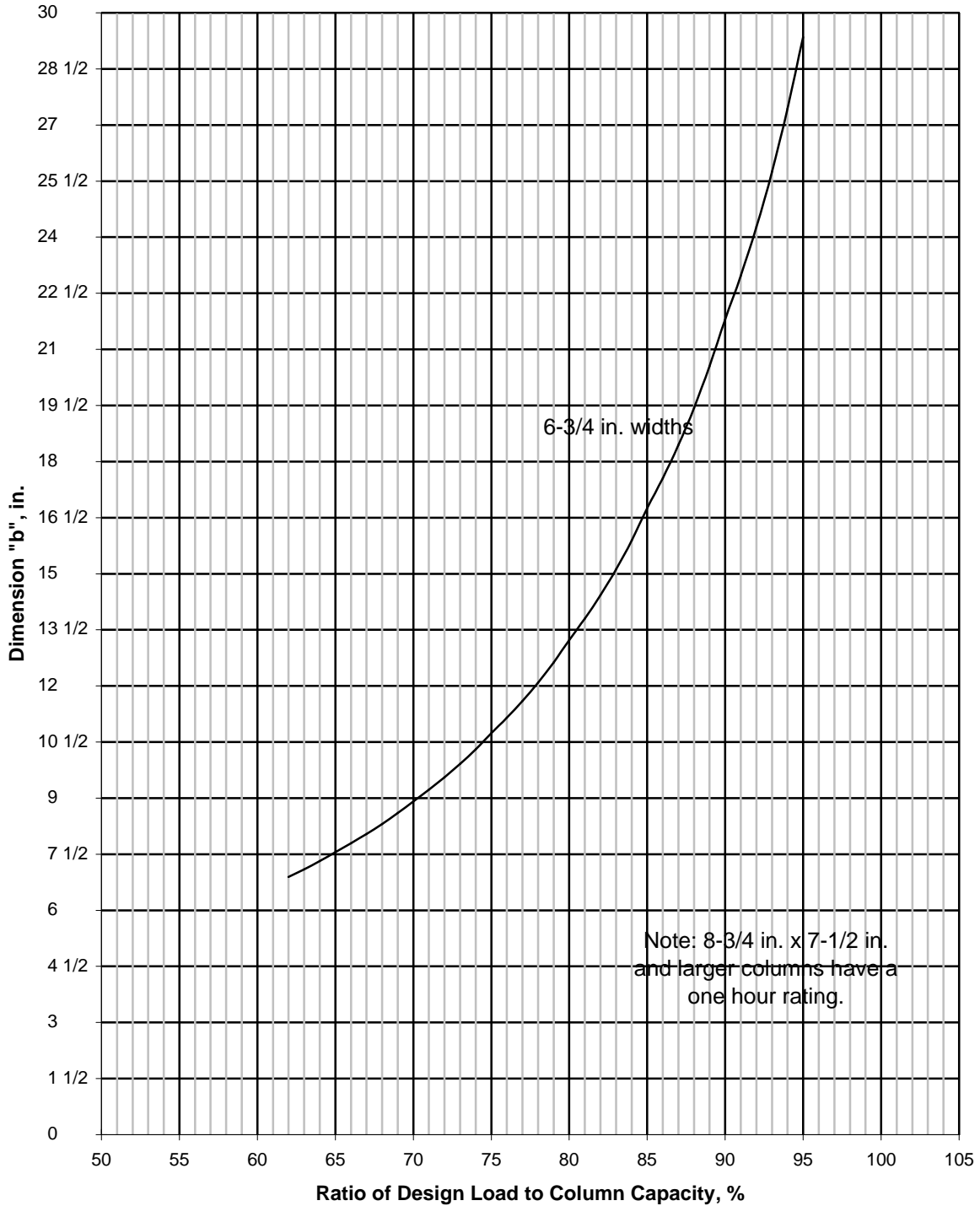

GRAPH 6